

SWITCHING POWER PROFESSIONAL AMPLIFIER

User's Manual

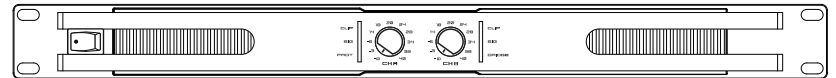

General Specifications		
Protections	Full short circuit, open circuit, thermal, ultrasonic, and RF protection stable into reactive or mismatched loads, turn ON/OFF, muting, tried crowbar.	
Controls	Front: AC switch, Input level control for each channel Rear: Mode selector, Cut off frequency selectors	
Indicators	SIGNAL: 2 green LED CLIP: 2 red LED POWER: 1 Green LED PROTECTION: red LED Bridged: 1 red LED	
Connectors	INPUT : Neutrik combo XLR/TRS OUTPUT: Speak-on jacks	
Power Supply	110V-120V or 220V-240V AC 50/60 Hz \pm 10%	
Dimensions(mm)	483(W)*360(D)*44(H)	
Weight	5.7kg	6.1kg

INDEX

01	SAFETY RELATED SYMBOLS	2
02	WARNING	2
03	IMPORTANT SAFETY INSTRUCTION	3
04	INTRODUCTION	4
05	CONTROL ELEMENTS	5
06	APPLICATIONS	9
07	WIRING CONNECTIONS	12
08	BLOCK DIAGRAM	14
09	TECHNICAL SPECIFICATINS	15

SAFETY RELATED SYMBOLS



The symbol is used to indicate that some hazardous live terminals are involved within this apparatus, even under the normal operating conditions.



The symbol is used in the service documentation to indicate that specific component shall be only replaced by the component specified in that Documentation for safety reasons.



Protective grounding terminal.



Alternating current /voltage.



Hazardous live terminal .

ON: Denotes the apparatus turns on.

OFF: Denotes the apparatus turns off, because of using the single pole switch, be sure to unplug the AC power to prevent any electric shock before you proceed your service.

WARNING: Describes precautions that should be observed to prevent the danger of injury or death to the user.



Disposing of this product should not be placed in municipal waste and should be separate collection.

CAUTION: Describes precautions that should be observed to prevent danger of the apparatus.

WARNING

• Power Supply

Ensure the source voltage matches the voltage of the power supply before turning ON the apparatus.

Unplug this apparatus during lightning storms or when unused for long periods of time.

• External Connection

The external wiring connected to the output hazardous live terminals requires installation by an instructed person, or the use of ready-made leads or cords.

• Do not Remove any Cover

There are maybe some areas with high voltages inside, to reduce the risk of electric shock, do not remove any cover if the power supply is connected.

The cover should be removed by the qualified personnel only.

No user serviceable parts inside.

• Fuse

To prevent a fire, make sure to use fuses with specified standard (current, voltage, type). Do not use a different fuse or short circuit the fuse holder.

Before replacing the fuse, turn OFF the apparatus and disconnected the power source.

• Protective Grounding

Make sure to connect the protective grounding to prevent any electric shock before turning ON the apparatus.

Never cut off the internal or external protective grounding wire or disconnect the wiring of protective grounding terminal.

• Operating Conditions

This apparatus shall not be exposed to dripping or splashing and that no objects filled with liquids, such as vases, shall be placed on this apparatus.

TECHNICAL SPECIFICATIONS

Power Specifications(tolerance +/-5%)		1000.2	1500.2
Stereo Mode (Both Channels Drive)	2 ohms(EIAJ)	2000W*2	2800W*2
	4 ohms(RMS)	900W*2	1500W*2
	8 ohms(RMS)	600W*2	900W*2
Bridge Mono Mode	8 ohms(RMS)	1800W	1000W
	4 ohms(EIAJ)	4000W	1800W
Electrical Specification			
Input Sensitivity (Limit Off)		0.9-1.1V(0+/-1dBv)	0.9-1.1V(0+/-1dBv)
Input Impedance		20k ohms balanced or 10k Ohms unbalanced	20k ohms balanced or 10k Ohms unbalanced
Frequency Response (at 10dB Rated Output Power 8Ω)		20Hz ~ 20KHz(+0/-1dB)	20Hz ~ 20KHz(+0/-1dB)
Voltage Gain		37+/-0.5dB	38+/-0.5dB
THD+N (Ref. 1K 1/8 Rated Power,A-Weighted)		<0.1%	<0.1%
S/N rate (Ref. Rated Power, A-Weighted)		>100dB	>100dB
Crosstalk (Below Rated Power)		>70dB	>70dB
Damping Factor(1K 8 ohms)		>200	>200
Power/Output Circuitry		Switching Power Class D	Switching Power Class D

BLOCK DIAGRAM

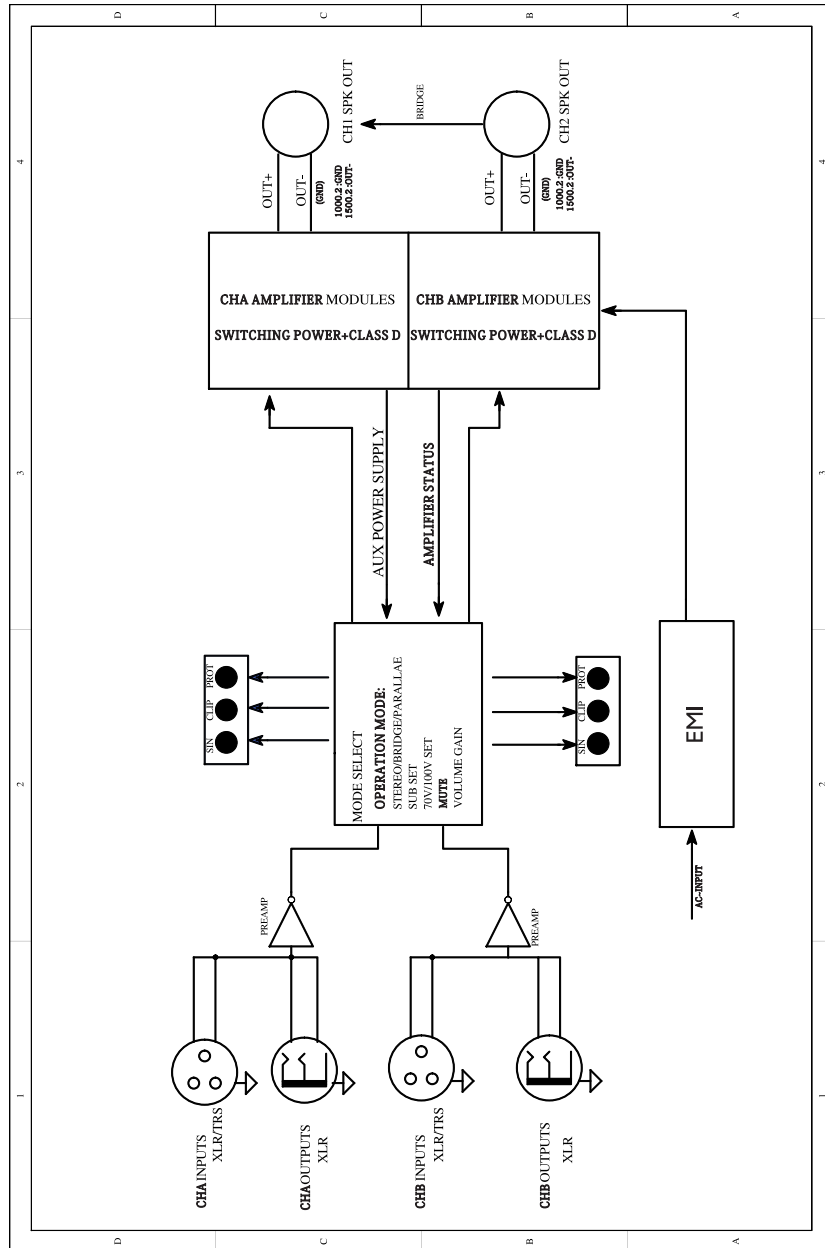

To reduce the risk of fire or electric shock, do not expose this apparatus to rain or moisture.

Do not use this apparatus near water. Install in accordance with the manufacture-r's instructions. Do not install near any heat sources such as radiators, heat registers, stoves, or other apparatus (including amplifiers) that produce heat. Do not block any ventilation openings.

No naked flame sources, such as lighted candles, should be placed on the apparatus.

IMPORTANT SAFETY INSTRUCTIONS

- Read these instructions.
- Follow all instructions.
- Keep these instructions.
- Heed all warnings.
- Only use attachments/accessories specified by the manufacturer.

• Power Cord and Plug

Do not defeat the safety purpose of the polarized or grounding type plug.

A polarized plug has two blades with one wider than the other. A grounding type plug has two blades and a third grounding prong. The wide blade or the third prong are provided for your safety. If the provided plug does not fit into your outlet, consult an electrician for replacement of the obsolete outlet.

Protect the power cord from being walked on or pinched particularly at plugs, convenience receptacles, and the point where they exit from the apparatus.

• Cleaning

When the apparatus needs a cleaning, you can blow off dust from the apparatus with

a blower or clean with rag etc.

Don't use solvents such as benzol, alcohol, or other fluids with very strong volatility and flammability for cleaning the apparatus body. Clean only with dry cloth.

• Servicing

Refer all servicing to qualified personnel. To reduce the risk of electric shock, do not perform any servicing other than that contained in the operating instructions unless you are qualified to do so .

Servicing is required when the apparatus has been damaged in any way , such as power supply cord or plug is damaged , liquid has been spilled or objects have fallen into the apparatus, the apparatus has been exposed to rain or moisture , does not operate normally, or has been dropped.

The mains plug is used as the disconnect device, the disconnect device shall remain readily operable.

INTRODUCTION

The product switching power professional Amplifier is designed for professional use on stage. The high-quality components and the carefully designed circuits ensure excellent audio performance and an extremely linear frequency response. In fact, the switching technology offers, together with an increased efficiency and a better control of heat dissipation than conventional power supply systems, a drastic reduction of dimensions and weight, for easier transportation and installation. This Amplifier guarantees total reliability and a trouble-free use even in the most demanding conditions. We believe the product will provide a perfect performance, what you get is unprecedented performance at an incredibly attractive price.

Features:

- *High current switching power allowing high power output with low noise and low distortion
- *Substantial protection circuitry like thermal, short circuit, power on/off muting and Therefore protection
- *Built-in limiter
- *Balanced XLR-TRS combo input jack & XLR/Link output
- *Speakon output connectors
- *front mounted gain controls for easy access
- *Signal, Clip protect, and Power LED indicators to monitor performance.
- *Stereo/Parallel/Bridged/Sub/70V/100V/Mute mode select.

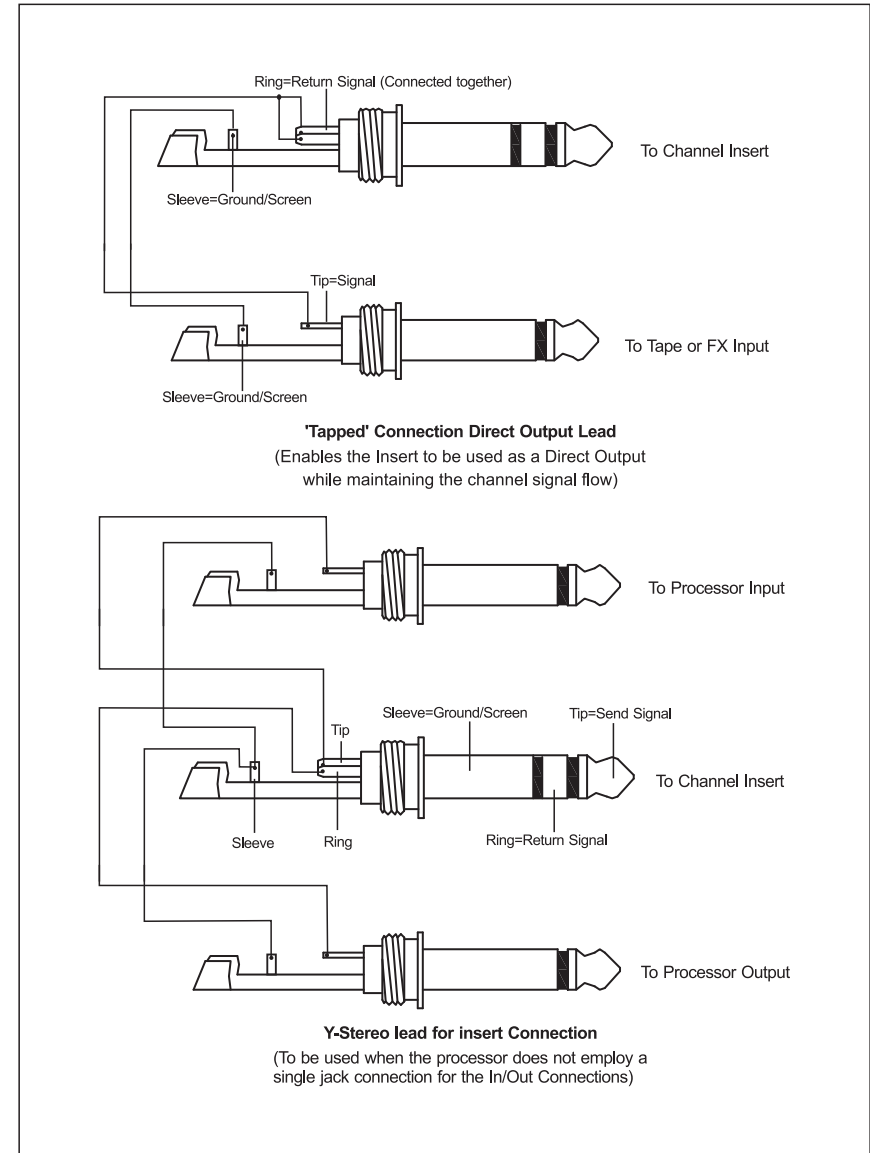

WIRING CONNECTIONS

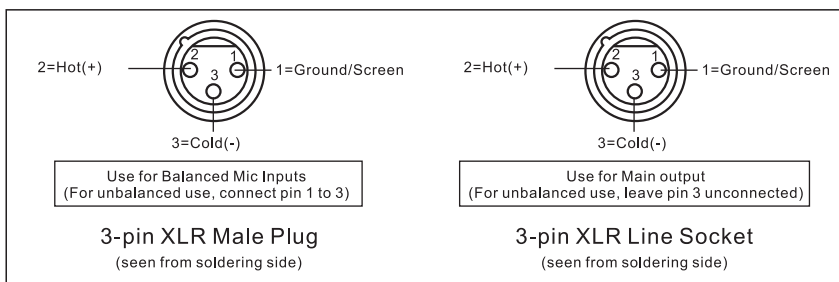
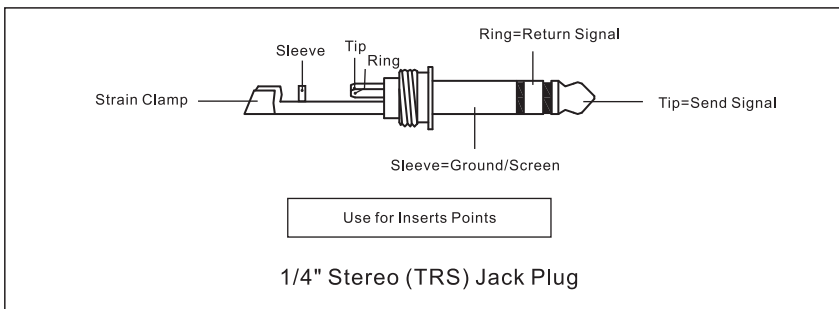
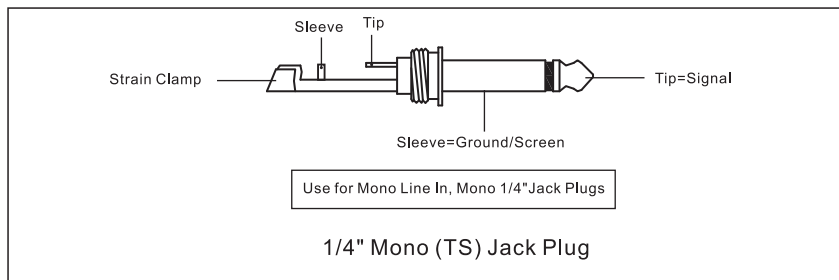
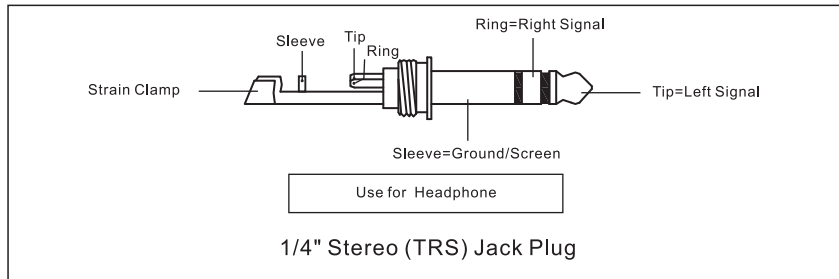

CONTROL ELEMENTS

FRONT PANEL

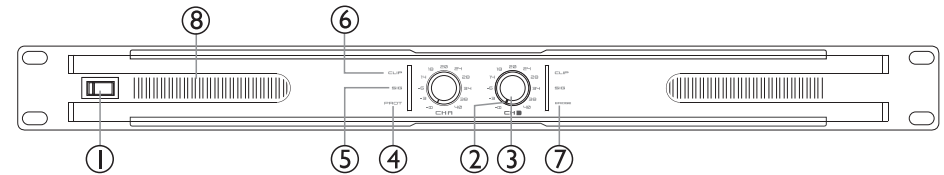

- ① **Power Switch**
It switches ON/OFF the unit main power.
- ② **Power Led**
The Power LED lights up when the amplifier is powered on.
- ③ **Level Control**
These volume controls adjust the volume level.
- ④ **Protection LED**
In normal operation, the LED will not light up; If the LED lights red, it means the unit stay in protection without sound output.
- ⑤ **Signal LED**
These green LEDs light up when the respective channel's output signal pass through.
- ⑥ **Clip LED**
The red LED lights up when the input signal is too large, and when the input signal decreases the LED will turn off.
- ⑦ **Bridged LED**
The Bridged LED lights up when the amplifier stay Bridged Mode.
- ⑧ **Air Intake Vents**
The unit employ a variable speed internal cooling fan to intake the air through front grill to keep it running cool even under extreme operating conditions. Please keep these vents clear and free from obstruction at all times to insure proper cooling.

REAR PANEL

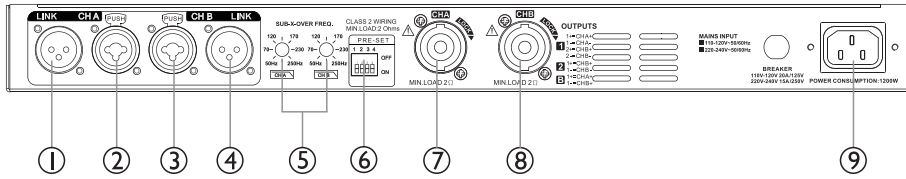

① Channel A Link Out

② Channel A XLR/TRS Input

This XLR/TRS jack will accept any balanced or unbalanced low impedance line level source by means of a three-pin XLR/TRS plug. The wiring for the plug is as follows: Pin 1 (Sleeve)=Ground, Pin 2 (TIP)=Signal+, Pin 3 (Ring)=Signal-.

③ Channel B TRS/XLR Input

This XLR/TRS jack will accept any balanced or unbalanced low impedance line level source by means of a three-pin XLR/TRS plug. The wiring for the plug is as follows: Pin 1 (Sleeve)=Ground, Pin 2 (TIP)=Signal+, Pin 3 (Ring)=Signal-.

④ Channel B Link out

⑤ SUB-X-OVER FREQ

Cut off frequency selectors for low-pass (SUB) filters, The value can be set from 50Hz to 250Hz. X-OVER FREQ is available in Mode 4 (SUB-Stereo) and Mode 5 (SUB-Bridged) only.

⑥ MODE

Mode 1: CHA/CHB stereo

Input and output channels are independent.

Mode 2: CHA/CHB parallel

Outputs are the same with any channel input.

Mode 3: CHA/CHB Brided

Input the signal to channel A, connect the speaker's "+" to the output A+, connect speaker's "-" to the output B+.

Mode 4: CHA/CHB sub-Stereo

ChA and CHB are stereo, output signal is low frequency, X-over FREQ CHA/CHB is available.

70V-Stereo Operation

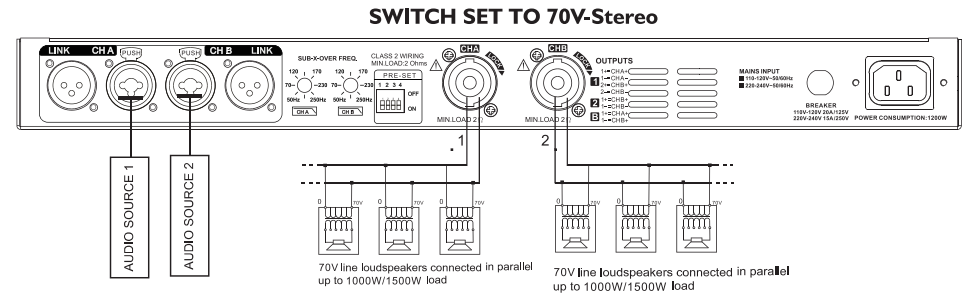

100V-Bridged Operation

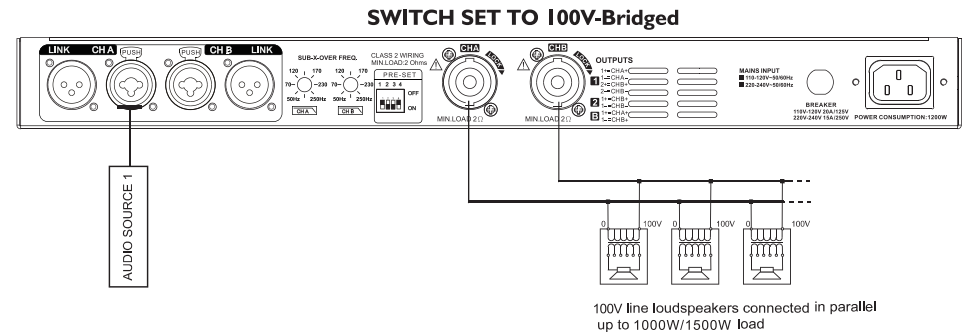

Patching two bridge mono mode system

Two bridge mono amplifiers can be patched together (operated in mono mode) with connecting signal cable between their input jacks. The signal smart switch must be set to the bridge position.

SWITCH SET TO BRIDGE

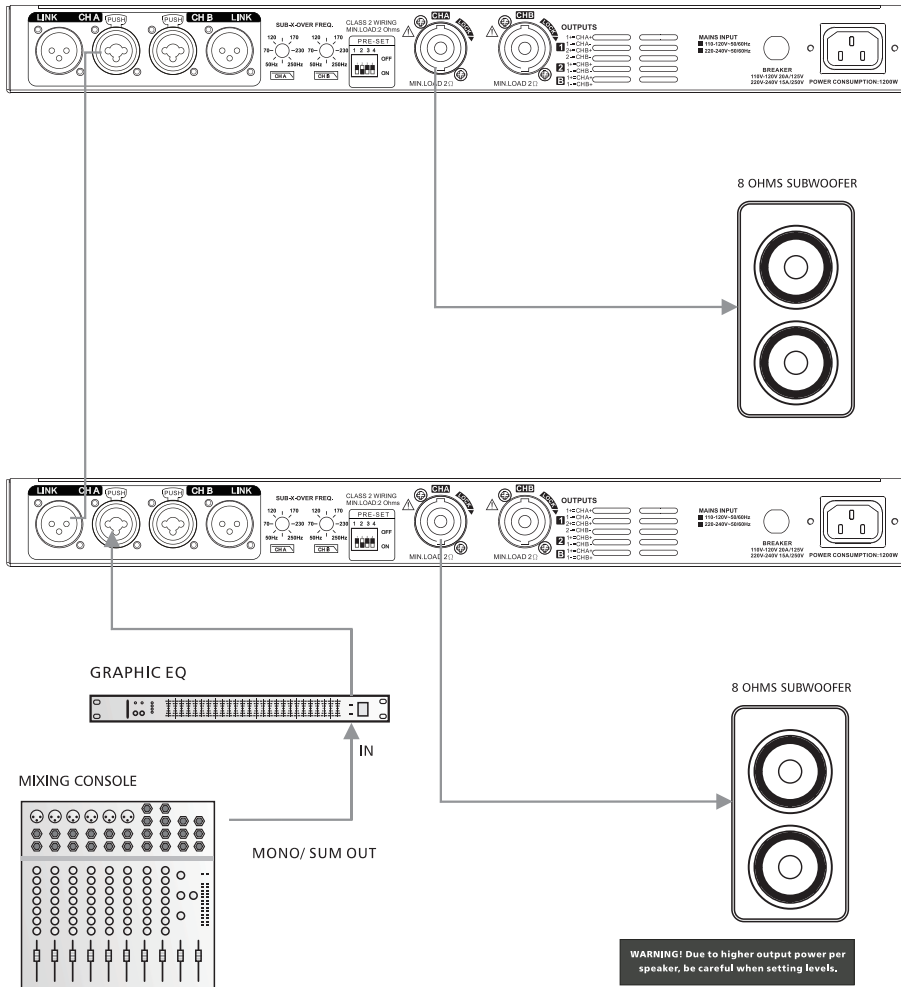

Mode 5: CHA/CHB sub-Bridged

CHA/CHB are Bridged, input the signal to CH1, output signal is Bridged, X-OVER FREQ CH1 is available.

Mode 6: 70V-Stereo

CHA and CHB are stereo 70V line output, the min load is 4Ω.

Mode 7: 100V-Bridged

CHA and CHB are Bridged, input the signal to CH1, output signal is 100V Bridged, the min load is 4Ω.

Mode 8: NC

Not used

Mode 9: Mute

The amplifier will be muted by turning on the switch.

Preset				Mode
1	2	3	4	
OFF	OFF	OFF	OFF	STEREO
ON	OFF	OFF	OFF	PARALLEL
OFF	ON	OFF	OFF	BRIDGED
ON	ON	OFF	OFF	SUB-STEREO
OFF	OFF	ON	OFF	SUB-BRIDGED
ON	OFF	ON	OFF	70V-STEREO
OFF	ON	ON	OFF	100V-BRIDGED
ON	ON	ON	OFF	NC
			ON	Mute

⑦ CHA SPEAKON NL-4R

Connect the amplifier to you speaker with these speaker jacks.

⑧ CHB SPEAKON NL-4R

Connect the amplifier to you speaker with these speaker jacks.

⑨ AC Input

Use it to connect your product to the supplied AC cord.

APPLICATIONS

Stereo Operation

The product can be used in the stereo mode as two separate 1000/1500 watt units, each capable of driving loads down to 4 ohms. Each channel operates independently and has its own input connectors, sensitivity level controls, signal indicator LEDs, automatic limiter, fault protection circuitry, power amp, and speaker outputs. In the stereo mode, the signal smart switch must be set to the stereo position. One application of the stereo mode uses one channel of the amplifier for the left house speakers and the other channel for the right. The mixing board channels can be panned left or right according to the position of the instruments on the stage. This approach provides a more accurate reproduction of the live performance.

SWITCH SET TO STEREO

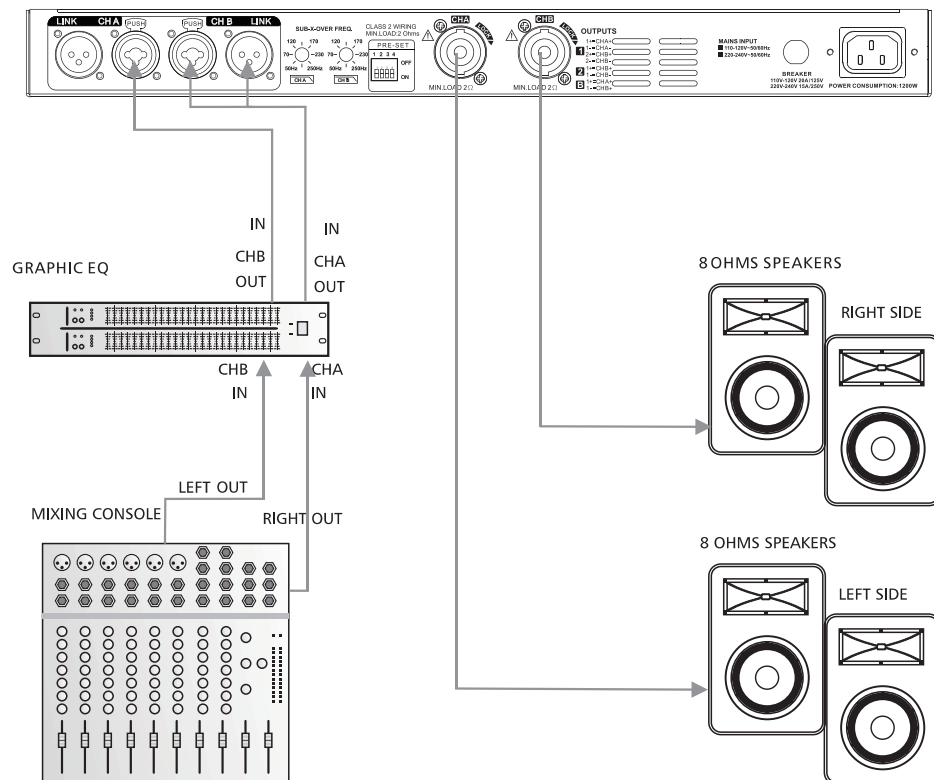

Mono Bridge Operation

The two internal power amplifiers (CHA and CHB) can be bridged together to form a single, higher powered amp. This is especially useful when using the amplifier to power a subwoofer. In the mono mode, the amplifier uses the channel 1 input jacks and sensitivity control (channel 2's are disabled). When operation in this mode, each channel is independently protected. The signal smart switch must be set to the bridge position and the minimum speaker load impedance must be 4 ohms.

SWITCH SET TO BRIDGE

